

## Assembly of the needle threader of a sewing machine Brother

The needle threader is composed of three parts (see photo). You must put these pieces together according to the drawing below.



Fig. 1

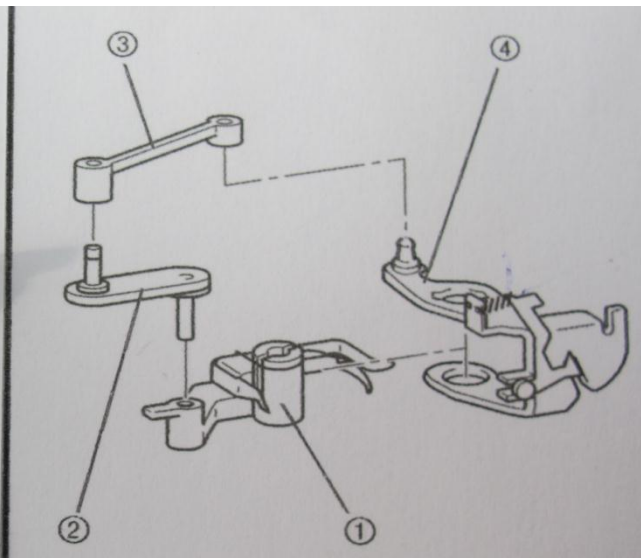

Fig.2

If you have assembled the parts you should see the following:



Fig. 3

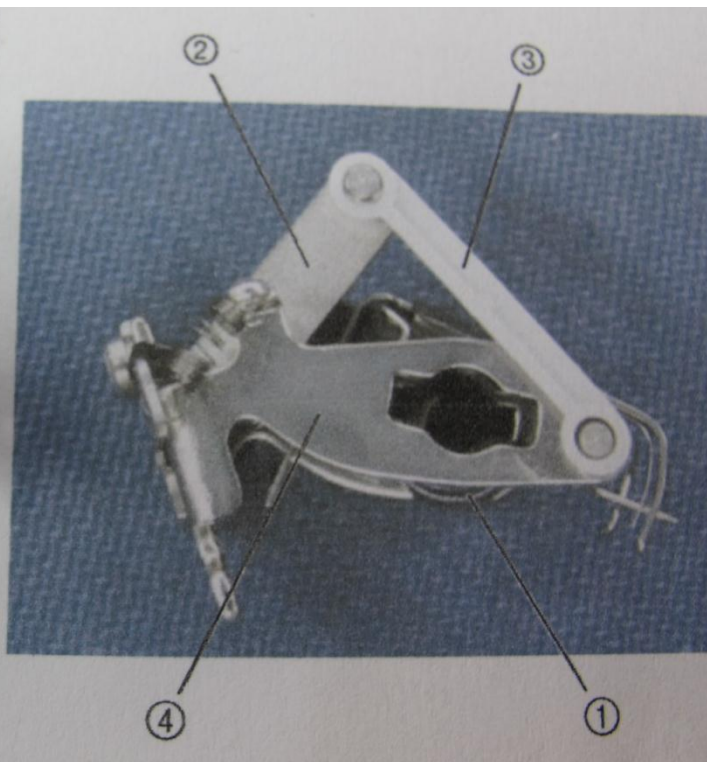

Fig.4

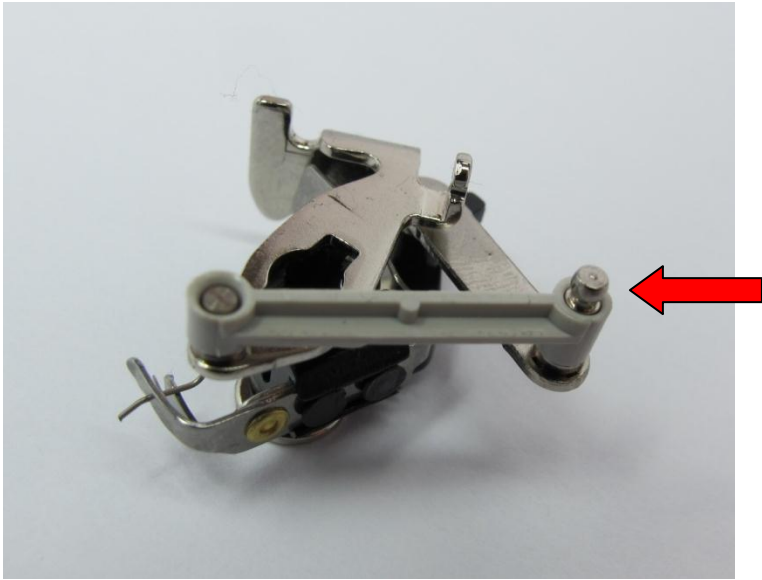

Fig.5

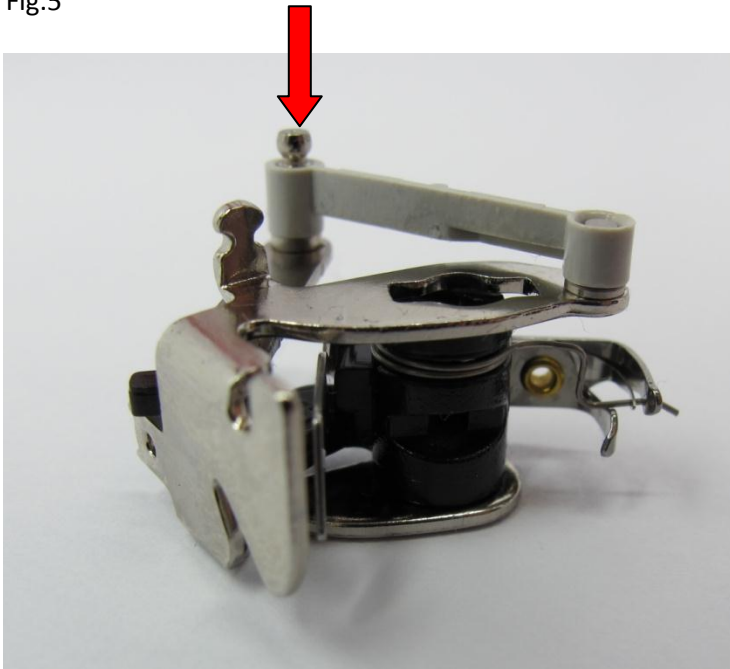

Fig. 6

Slide this assembly on the left axis of the presser foot on the sewing machine (see photo). The parts sticking out must fall exactly into the slots of the needle threader.

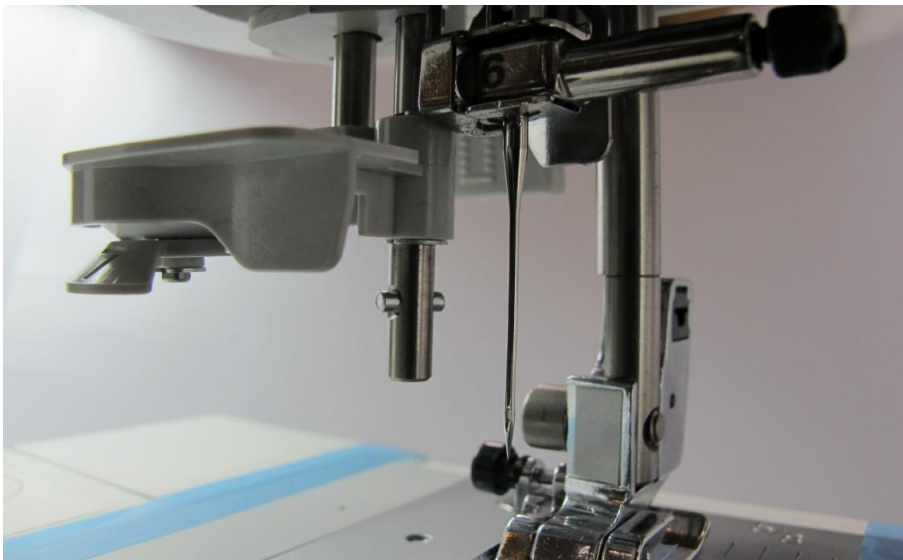

Fig.7

If the needle threader machine is placed, you can verify that it works correctly by pushing the lever on the left side of the machine down.

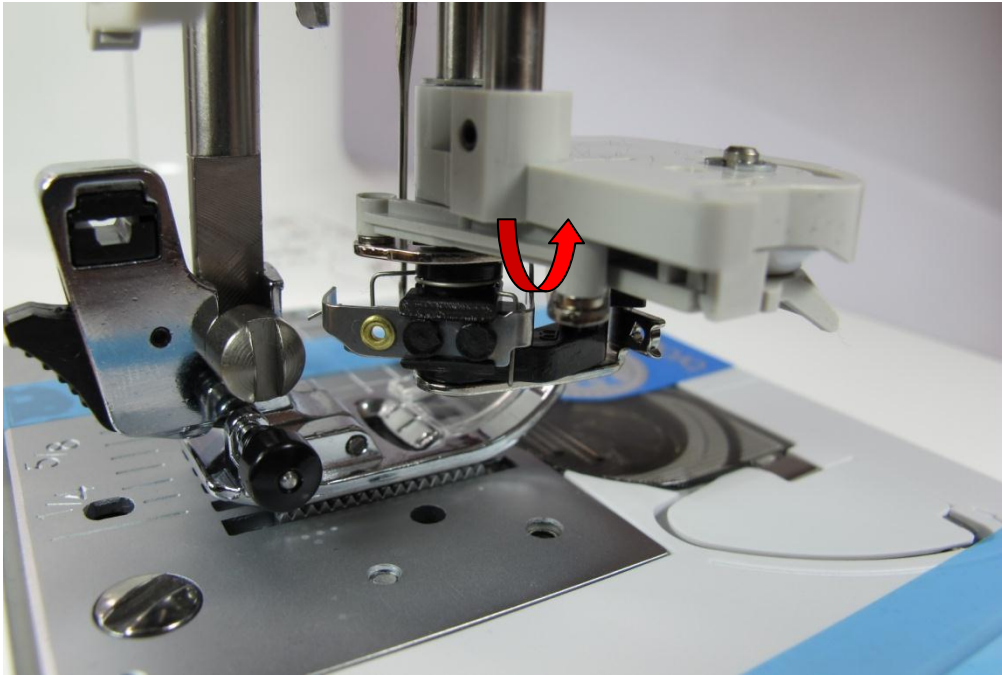

Fig.8



Fig.9

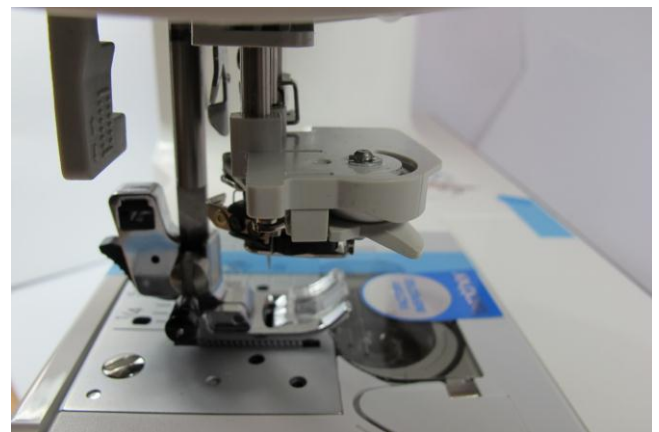

Fig. 10

Note that the protruding pin of the component 2 (See Figure 2) should be in the slot. This pin is marked with a red arrow on the drawings 3,5,6 and 8. This is the pin that makes the needle threader rotate to take the thread through the needle.

If the needlethreader doesn't rotate, the pin isn't correctly placed into the slot.